

Thermomagnetic device circuit breaker - CB TM1 3A SFB P - 2800838

Please be informed that the data shown in this PDF Document is generated from our Online Catalog. Please find the complete data in the user's documentation. Our General Terms of Use for Downloads are valid (<http://phoenixcontact.com/download>)



Thermomagnetic device circuit breaker, 1-pos., tripping characteristic SFB, 1 changeover contact, plug for base element.

Your advantages

- ✓ Individually adjustable with protective plugs
- ✓ Fuse protection for above-average conductor lengths with the aid of the SFB characteristic curve
- ✓ Protective plug with fixed nominal current value as protection against unintentional changes
- ✓ Increased safety with electrical isolation in the event of errors



Key Commercial Data

Packing unit	1 pc
GTIN	 4 046356 689892
GTIN	4046356689892
Weight per Piece (excluding packing)	40.000 g
Custom tariff number	85362010
Country of origin	Indonesia

Technical data

Dimensions

Height	45 mm
Width	12.3 mm
Depth	52 mm
Complete module height	90 mm
Complete module width	12.3 mm

Thermomagnetic device circuit breaker - CB TM1 3A SFB P - 2800838

Technical data

Dimensions

Complete module depth	77.3 mm
-----------------------	---------

Ambient conditions

Ambient temperature (operation)	-30 °C ... 60 °C
Ambient temperature (storage/transport)	-40 °C ... 80 °C
Humidity test	240 h, 95 % RH, 40 °C
Shock (operation)	30g (IEC 60068-2-27, Test Ea)
Vibration (operation)	8g (IEC 60068-2-6, Test Fc)
Degree of protection	IP30 (Actuation area)

General

Assembly note	When mounted in rows, the nominal device current can be limited to just 80% or must be oversized accordingly.
Flammability rating according to UL 94	V-0
Mounting type	on base element
Color	gray
Number of positions	1
Insulating material group	II
Degree of pollution	2
Type	Male

Electrical data

Fuse type	SFB
Rated surge voltage	2.5 kV (Increased insulation in actuation area)
Rated voltage	50 V DC (IEC 60934)
	50 V DC (UL 1077)
	50 V DC (UL 508 - with plug-in base)
Rated current I_N	3 A (IEC 60934)
	3 A DC (low-induction load according to UL 1077)
	3 A DC (low-induction load according to UL 508 - with plug-in base)
Rated insulation voltage U_i	277 V AC (UL 1077)
	250 V AC (IEC 60934)
Power dissipation	1.26 W (in nominal operation per channel)
Device resistance	140 mΩ
Insulation resistance R_{iso}	> 100 MΩ (500 V DC)
Type of actuation	S type
Tripping method	TM (thermomagnetic)
Tripping level	Trip-free mechanism (positive)
Rated short-circuit switching capacity I_{cn}	600 A (50 V DC)

Thermomagnetic device circuit breaker - CB TM1 3A SFB P - 2800838

Technical data

Electrical data

Required backup fuse	15 A ($I > I_{cn}$)
Short-circuit switching capacity	1000 A AC (277 V AC)
	1000 A DC (50 V DC)
Dielectric strength	3000 V AC (Actuation area)
	1500 V AC (Main to auxiliary circuit)
	1500 V AC (Open main circuit)
	1000 V AC (Open auxiliary circuit)
Voltage drop	0.42 V (at $1 \times I_n$)
Switching cycles, max.	6000 (at $1 \times I_n$)
Auxiliary circuit	277 V AC / 0.5 A (Low-induction)
	277 V AC / 1 A (Low-induction, maximum of 2000 cycles)
	50 V DC / 1 A (Low-induction)
Minimum auxiliary contact operating voltage	10 V
Maximum auxiliary contact operating voltage	240 V
	240 V
Minimum auxiliary contact operating current	10 mA
Maximum auxiliary contact operating current	1 A

Standards and Regulations

Standards/specifications	EN 60934
--------------------------	----------

Conformance/approvals

Designation	UL approval
Identification	UL Listed UL 508
	UL/C-UL Recognized UL 1077
Designation	CSA
Identification	CSA CAN/CSA-C22.2 No. 235-04
Designation	Shipbuilding approval
Identification	DNV GL

Environmental Product Compliance

REACH SVHC	Lead 7439-92-1
China RoHS	Environmentally Friendly Use Period = 25;
	For details about hazardous substances go to tab "Downloads", Category "Manufacturer's declaration"

Drawings

Thermomagnetic device circuit breaker - CB TM1 3A SFB P - 2800838

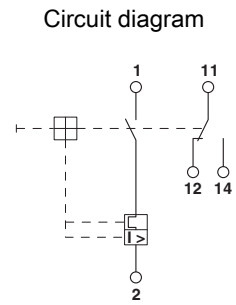
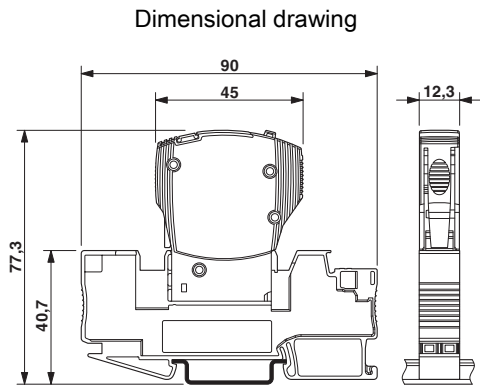

The figure shows the complete module consisting of a base element and connector

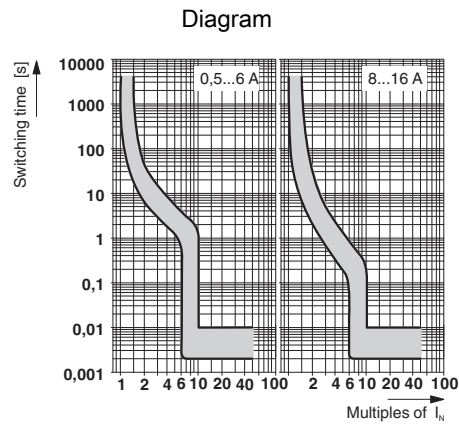

Trigger characteristic in the DC range

Thermomagnetic device circuit breaker - CB TM1 3A SFB P - 2800838

Application drawing

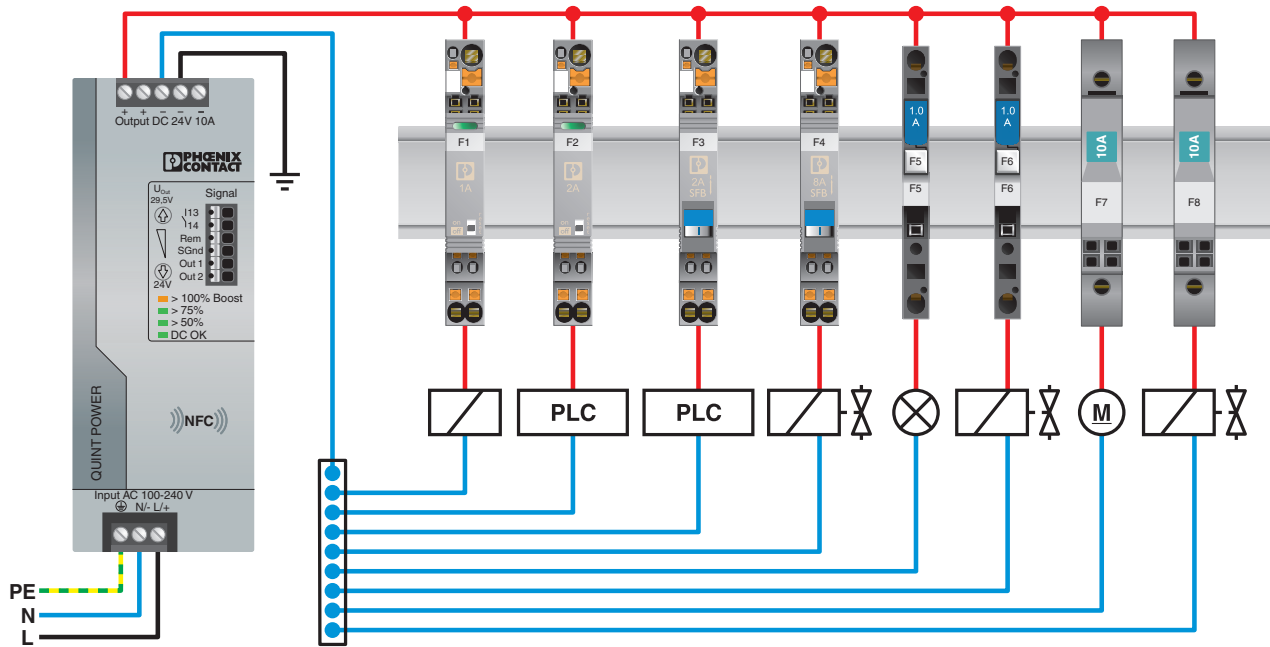

Thermomagnetic device circuit breaker - CB TM1 3A SFB P - 2800838

Application drawing



Classifications

eCl@ss

eCl@ss 10.0.1	27140401
eCl@ss 11.0	27140401
eCl@ss 4.0	27141100
eCl@ss 4.1	27141100
eCl@ss 5.0	27141100
eCl@ss 5.1	27141100
eCl@ss 6.0	27141100
eCl@ss 7.0	27141116
eCl@ss 9.0	27141116

ETIM

ETIM 3.0	EC000899
ETIM 4.0	EC000899

Thermomagnetic device circuit breaker - CB TM1 3A SFB P - 2800838

Classifications

ETIM

ETIM 6.0	EC000899
----------	----------

UNSPSC

UNSPSC 6.01	30211812
UNSPSC 7.0901	39121411
UNSPSC 11	39121411
UNSPSC 12.01	39121411
UNSPSC 13.2	39121410
UNSPSC 18.0	39121410
UNSPSC 19.0	39121410
UNSPSC 20.0	39121410
UNSPSC 21.0	39121410

Approvals

Approvals

Approvals

CSA / UL Listed / UL Recognized / cUL Recognized / cUL Listed / EAC / KC / DNV GL / CCC / EAC / VDE Zeichengenehmigung / cULus Recognized / cULus Listed

Ex Approvals

Approval details

CSA		http://www.csagroup.org/services-industries/product-listing/	2786957
-----	---	---	---------

UL Listed		http://database.ul.com/cgi-bin/XYV/template/LISEXT/1FRAME/index.htm	FILE E 172140
-----------	---	---	---------------

UL Recognized		http://database.ul.com/cgi-bin/XYV/template/LISEXT/1FRAME/index.htm	FILE E 140459
---------------	---	---	---------------

Thermomagnetic device circuit breaker - CB TM1 3A SFB P - 2800838

Approvals

cUL Recognized		http://database.ul.com/cgi-bin/XYV/template/LISEXT/1FRAME/index.htm	FILE E 140459
cUL Listed		http://database.ul.com/cgi-bin/XYV/template/LISEXT/1FRAME/index.htm	FILE E 172140
EAC			EAC-Zulassung
KC		http://eng.kcc.go.kr/user/ehpMain.do	SW05012-15002
DNV GL		https://approvalfinder.dnvgl.com/	TAE00003C7
CCC			2019010307158887
EAC			RU C- DE.*09.B.00169
VDE Zeichengenehmigung		http://www2.vde.com/de/Institut/Online-Service/VDE-gepruefteProdukte/Seiten/Online-Suche.aspx	40034683
cULus Recognized			

Thermomagnetic device circuit breaker - CB TM1 3A SFB P - 2800838

Approvals

cULus Listed



Accessories

Accessories

Bridge

Bridge - CB PT BRIDGE - 2801014



Bridge plug for bridging contacts 1 to 2 for CB base elements

Bridge - CB RC BRIDGE - 2801616



Bridge plug for bridging contacts 11 to 14 for CB base elements

Cutting tools

Front cutter - CUTFOX-FBS - 1212124



Cutting tool, for separating individual jumper bars from FBS ... plug-in bridges and EB ... insertion bridges

Jumper

Thermomagnetic device circuit breaker - CB TM1 3A SFB P - 2800838

Accessories

Plug-in bridge - FBS 2-6 - 3030336



Plug-in bridge, pitch: 6.2 mm, color: red

Plug-in bridge - FBS 3-6 - 3030242



Plug-in bridge, pitch: 6.2 mm, color: red

Plug-in bridge - FBS 4-6 - 3030255



Plug-in bridge, pitch: 6.2 mm, color: red

Plug-in bridge - FBS 5-6 - 3030349



Plug-in bridge, pitch: 6.2 mm, color: red

Plug-in bridge - FBS 10-6 - 3030271



Plug-in bridge, pitch: 6.2 mm, color: red

Thermomagnetic device circuit breaker - CB TM1 3A SFB P - 2800838

Accessories

Plug-in bridge - FBS 20-6 - 3030365



Plug-in bridge, pitch: 6.2 mm, color: red

Plug-in bridge - FBS 50-6 - 3032224



Plug-in bridge, pitch: 6.2 mm, color: red

Labeled terminal marker

Zack Marker strip, flat - ZBF 12 CUS - 0825018



Zack Marker strip, flat, can be ordered: Strip, white, labeled according to customer specifications, mounting type: snap into flat marker groove, for terminal block width: 12 mm, lettering field size: 5.15 x 12.15 mm, Number of individual labels: 5

Terminal marking

Zack Marker strip, flat - ZBF 12:UNBEDRUCKT - 0809735



Zack Marker strip, flat, Strip, white, unlabeled, can be labeled with: PLOTMARK, CMS-P1-PLOTTER, mounting type: snap into flat marker groove, for terminal block width: 12 mm, lettering field size: 5.15 x 12.15 mm, Number of individual labels: 5

Necessary add-on products

Thermomagnetic device circuit breaker - CB TM1 3A SFB P - 2800838

Accessories

Base element - CB 1/6-2/4 PT-BE - 2800929



Base element with push-in connection technology for CB ... device circuit breakers

Base element - CB 1/10-1/10 UT-BE - 2801305



Base element with screw connection technology for CB... device circuit breakers
